

HKS patio doors - DDR-92 system

tilt and slide

HKS patio doors - System DDF

Tilt-and-slide solution popular among investors who choose combinations of prestigious material and functional opening.

The simplicity of the system's operation allows the movable sash to be fully opened and tilted along the top edge, giving you the ability to comfortably ventilate your rooms. The simple operation and handling of the system allowed us to obtain very favorable price conditions, high quality and modern design.

The optimization of production costs determines the high availability of the product also for customers with more limited budgets - so that elegant and fashionable large glazing can take hold in any home.

HKS wooden patio doors are available in the following series:

- DDF-68
- DDF-78
- DDF-92
- DDR-68
- DDR-78
- DDR-92
- DDA-78
- DDF-68 AL
- DDF-78 AL
- DDF-92 AL

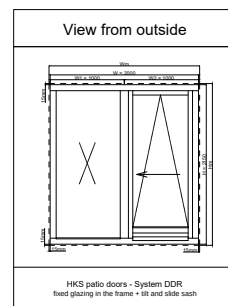
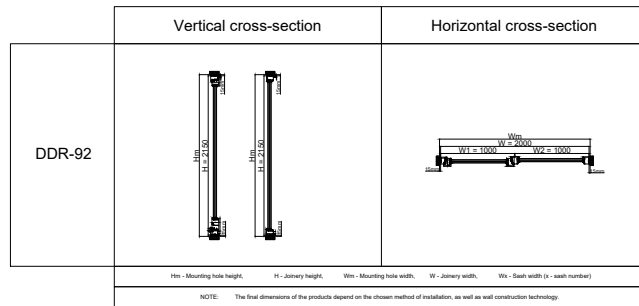

Parameters of wooden HKS patio doors (2000 x 2150)									
System	Glazing package	Uw	Ug	TET (g)	LT	Resistance to windload	Waterproofing	Air permeability	Rw
DDR-68	4x16x4	1,3	1	0,5	0,68	NPD	7A	4	26dB
DDR-78	4x14x4x14x4	0,93	0,6	0,53	0,74	2C	E900	4	27dB
DDR-92	4x16x4x16x4	0,93	0,5	0,38	0,59	2C	5A	4	27dB

Uw - heat transfer coefficient of the window, Ug - heat transfer coefficient of the glazing package, TET(g) - solar energy transmittance, LT - light transmission, Rw - acoustic properties